

4 3 2 1

F

F

E

E

D

D

C

C

B

B

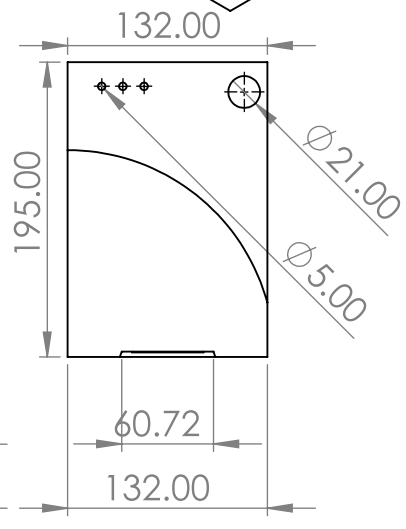
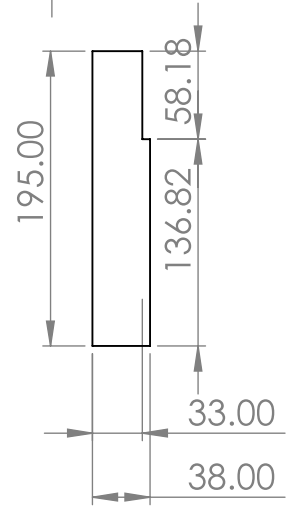
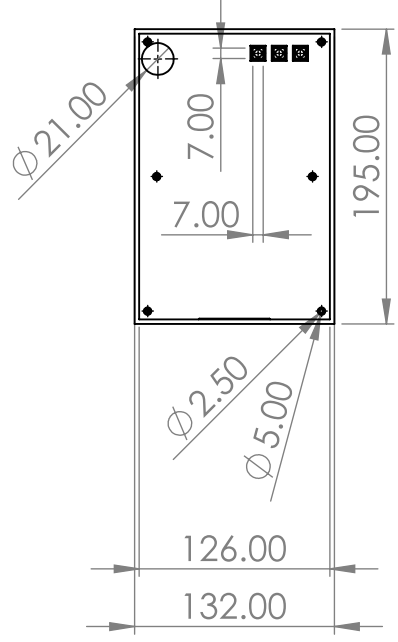
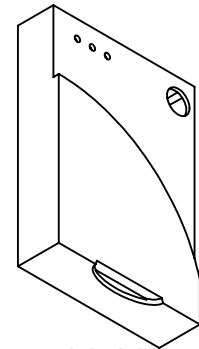
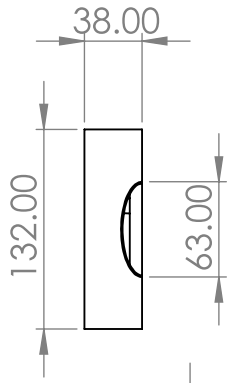
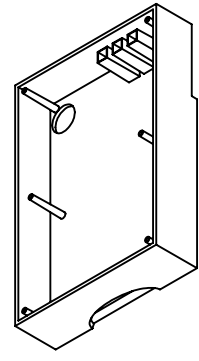
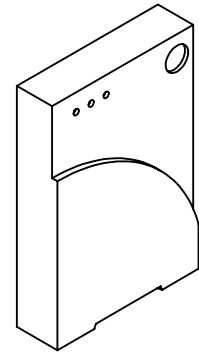
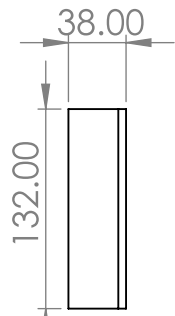
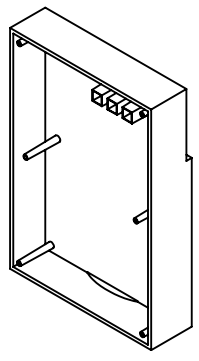

UNLESS OTHERWISE SPECIFIED:
DIMENSIONS ARE IN MILLIMETERS
SURFACE FINISH: Ok
TOLERANCES: Ok
LINEAR: Ok
ANGULAR: Ok

FINISH:
12/13/20

DEBURR AND
BREAK SHARP
EDGES
Ok

DO NOT SCALE DRAWING

REVISION

12/13/20

	NAME	SIGNATURE	DATE	
DRAWN	Wellington	A. Milani	12/13/20	
CHK'D	A. Milani	A. Milani	12/13/20	
APPV'D	A. Milani	A. Milani	12/13/20	
MFG	A. Milani	A. Milani	12/13/20	
Q.A	A. Milani	A. Milani	12/13/20	
				MATERIAL: ABS
				WEIGHT:

TITLE: Modelo: Frontal		A4
*** Configurações ***		
DWG NO. Montagem: Frontal		
SCALE: 1:5		SHEET 1 OF 1

4 3 2 1

A

A