

SRN-11

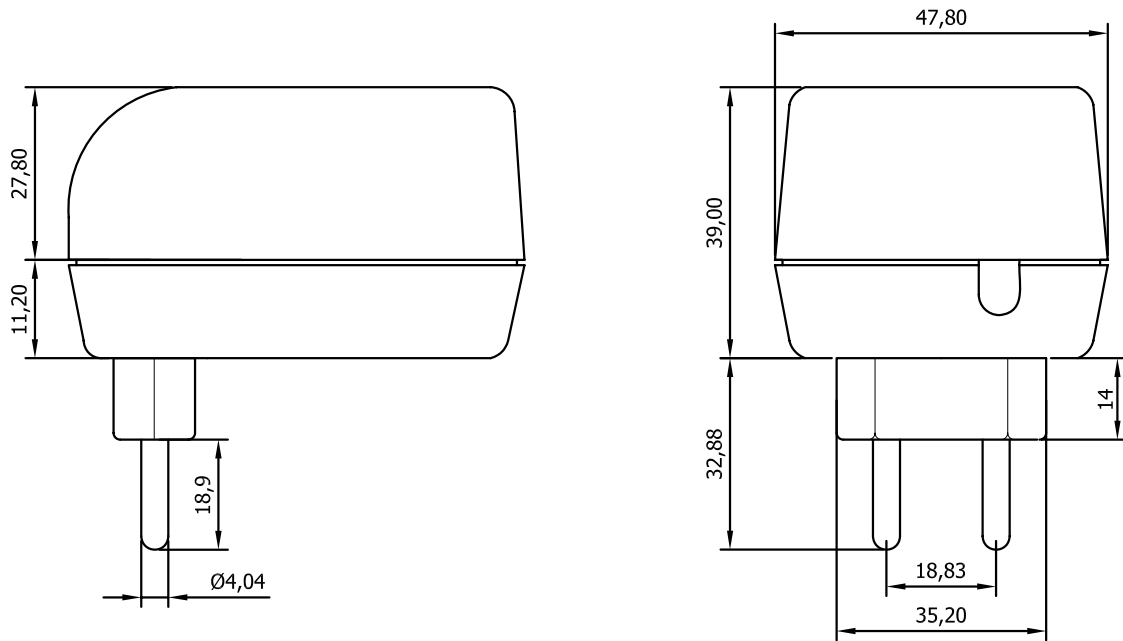

NOVA NORMA DA ABNT

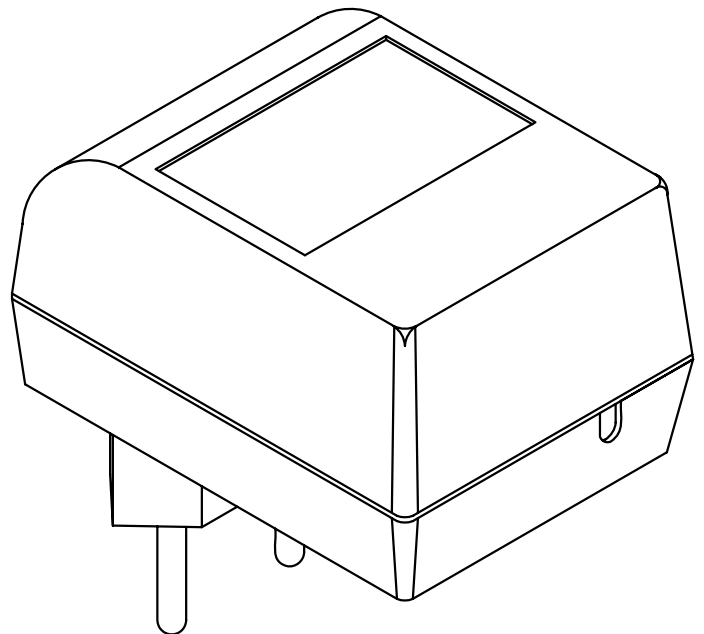
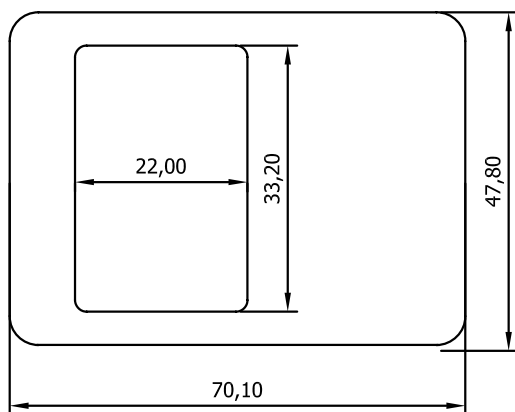

Rev.	Data	Descrição de Revisão
0	30/07/10	Liberação

**SANTA RITA
CAMPINAS**

Título: Caixa SRN-11

Desenho nº: **SRN 11**

Folha:
1 de 1

Escala:
S/E

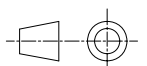

Arquivo: \\19

Desenhado por: Radamés

Revisado por: R. Toth

Aprovado por: Toth

Formato A4 (210 x 297mm)

PADRAO04.DWG